

0120

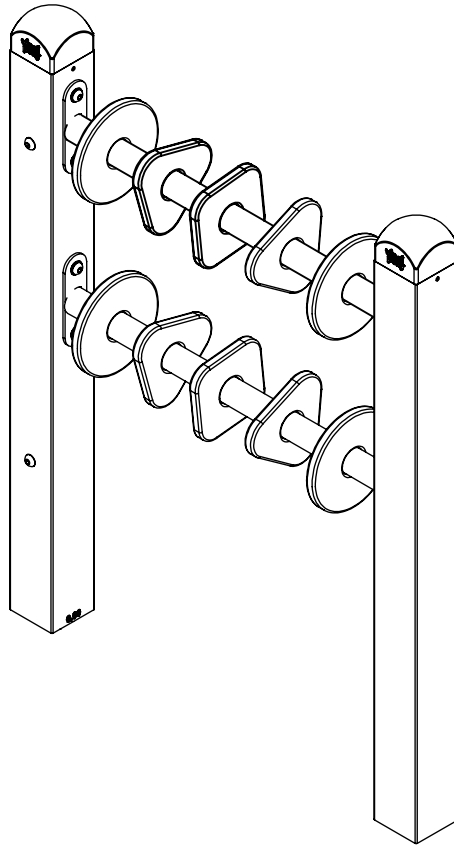

v011
27.01.2022
A. D.
[cm]

vinci
play

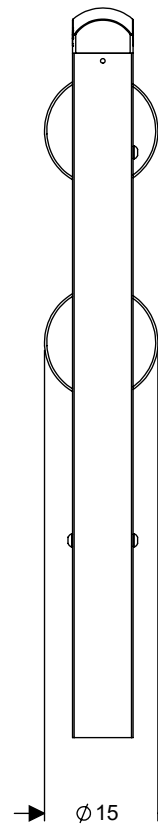
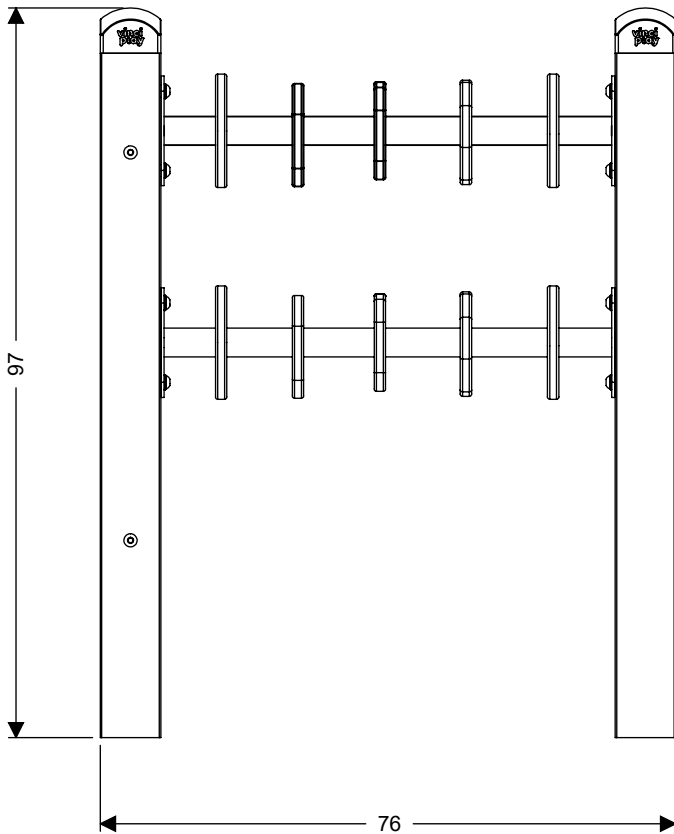
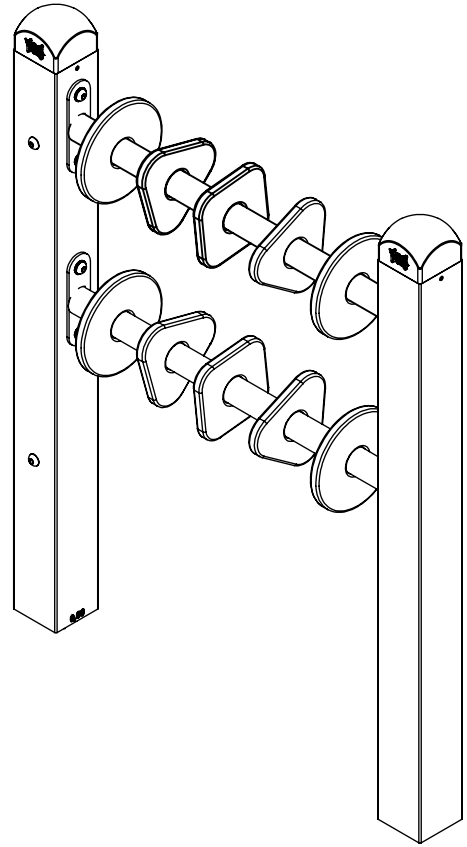
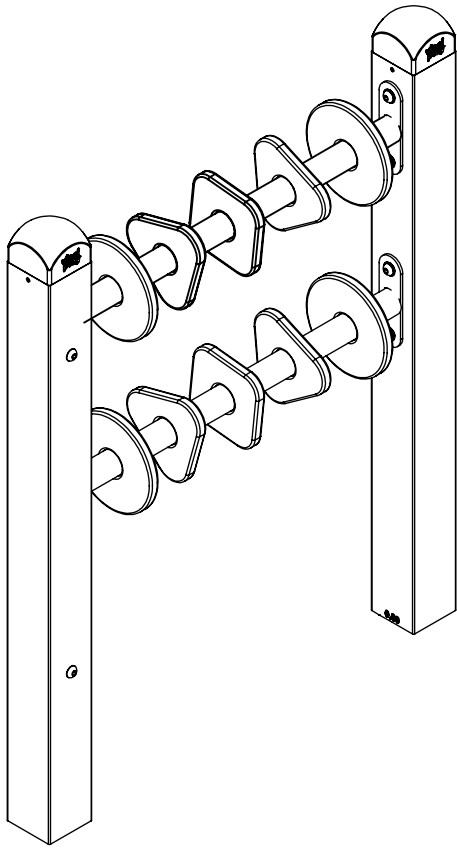

[cm]

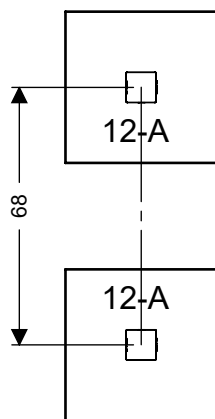
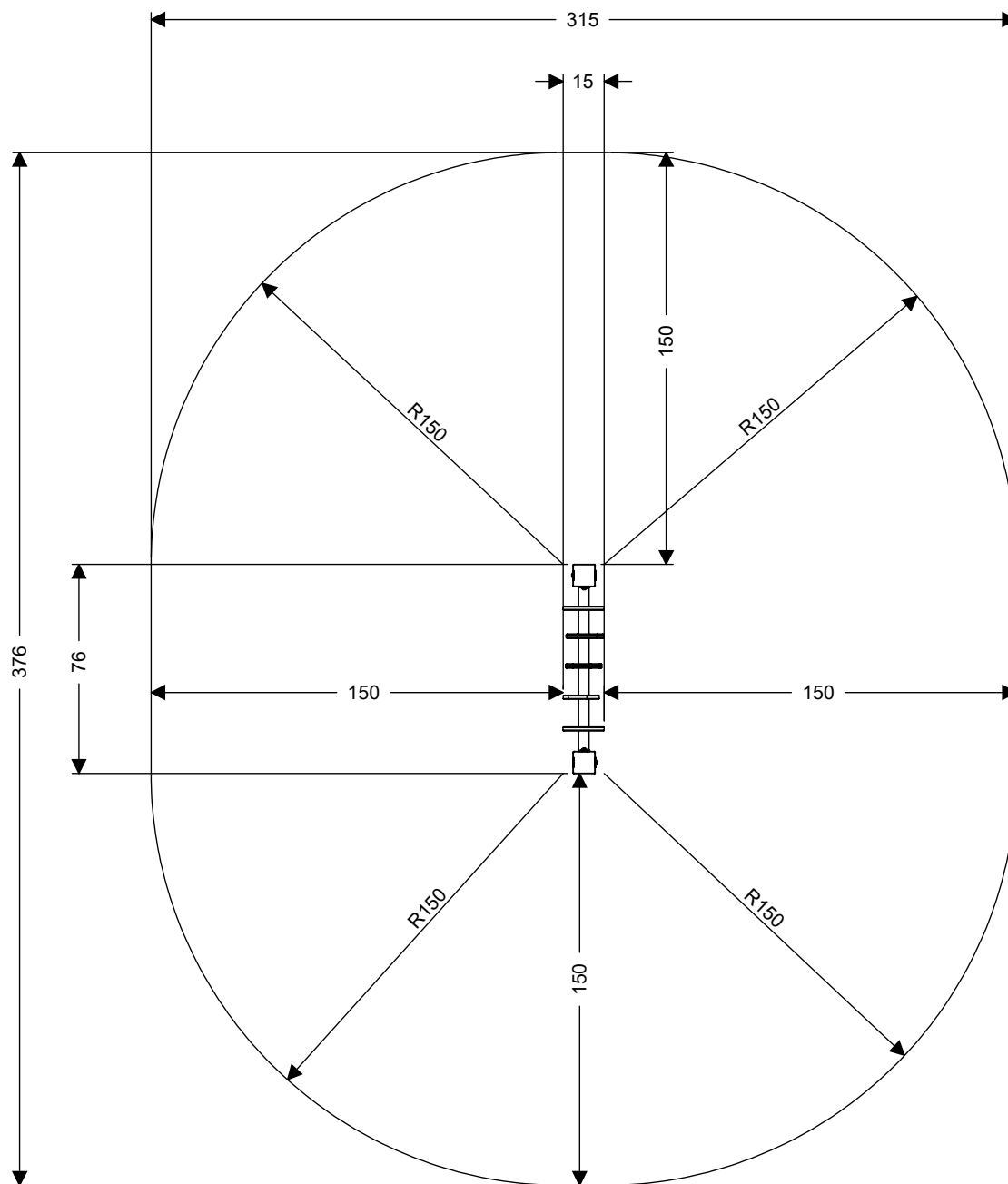

vinci
play

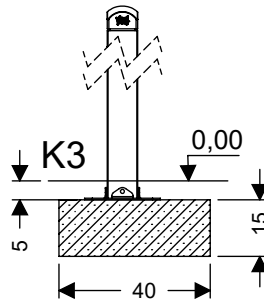
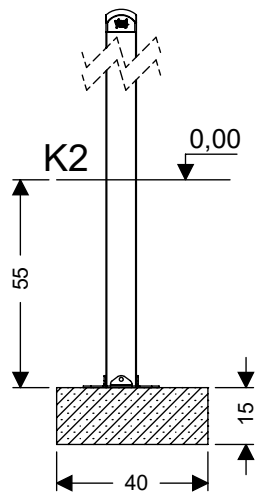
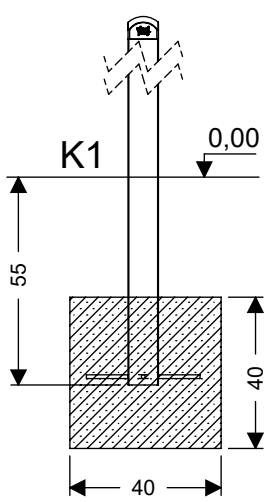

[cm]

vinci
play





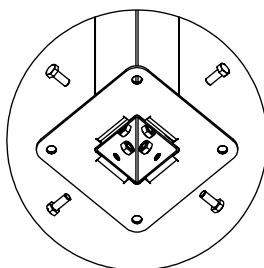
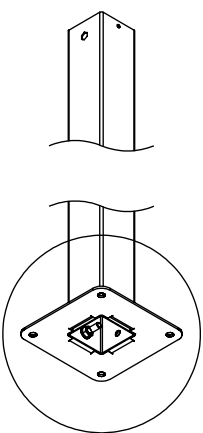
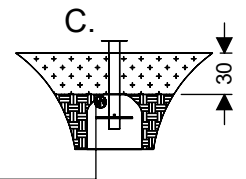
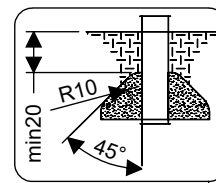
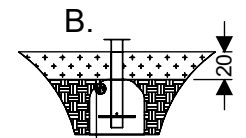
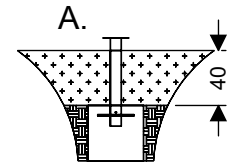
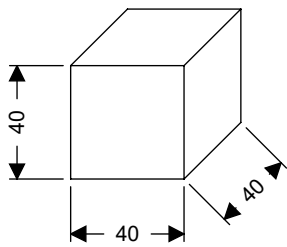



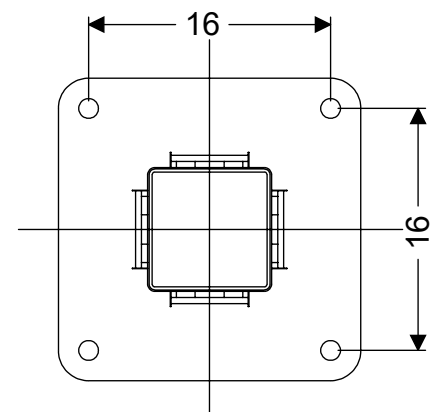
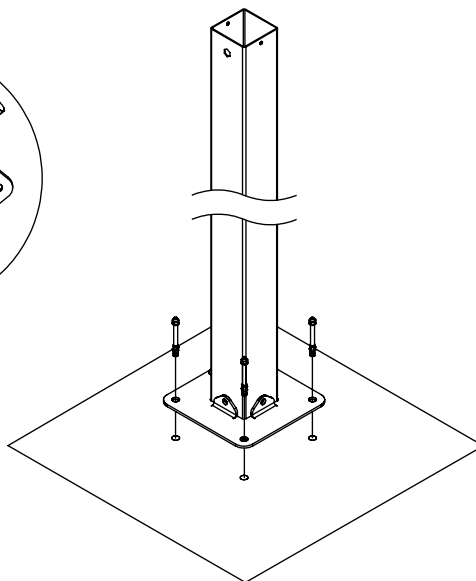



	K2, K3
M10x120 x8	
NOT INCLUDED	



E37



 x2	1h			48h	 K1 x2 >0,06m ³	 K2 x2 >0,02m ³	 K3 x2 >0,02m ³
 13	 17	 10					

[cm]

vinci
play



12-A
x2

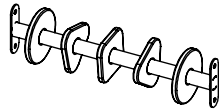

014107
x2

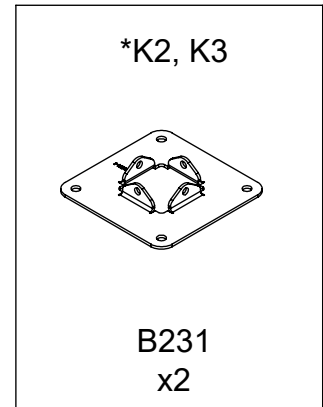

	ST/INOX
2x	E1
2x	E55
	E37
1x	V002

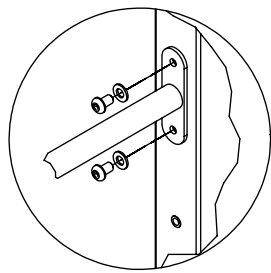

E1 x2

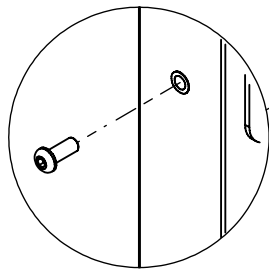

E55 x2

vinci
play
Art. №
year
201
EN 1176-1: 2017

Vinci Group Sp. z o.o.
Reguły, ul. Królowicza 6
05-816 Michałowice
POLAND
+48 42 203 24 99
www.vinci-play.com
www.babycam.pl

V002

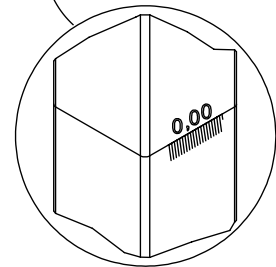

Part No:
000000-
00000

000000-00000

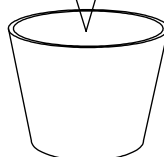

[cm]

vinci
play